

Install Instructions

25103-08



25108-08

Parts List

25117-08 Alternator & a/c bracket

1-25116A-08..alternator & a/c main bracket
1-25116B-08...a/c rear support bracket
1-P758.....automatic tensioner
1-TP3-1.040....tube spacer 1.040" long
1-TP3-1.630....tube spacer 1.630" long
1-S146.....5/16-18 x 1" shcs 1-
S160.....5/16-18 x 2 3/4" shcs
1-S216.....5/19-18 x 2" hex bolt
2-S248.....3/8-16 x 1" shcs
1-S282.....3/8-16 x 6" shcs
4-S338.....3/8-16 x 2 1/2" stud
2-S551.....8mm x 1.25 x 25mm shcs
2-S616.....5/16-18 lock nut
4-S660.....5/16" washer
2-S775.....threaded spacer 2.720" long
2-S777.....threaded spacer 2.820" long

25114-08 Power steering bracket

1-25114A-08..power steering main bracket
1-25114B-08..power steering rear bracket
2-TP3-.150....tube spacer .150" long
1-TP3-.300....tube spacer .300" long
2-TP3-.400....tube spacer .400" long
1-TP3-.700....tube spacer .700" long
4-S248.....3/8-16 x 1" shcs
2-S316.....3/8-16 x 3/4" button bolts
1-S322.....3/8-16 x 1 1/2" hex bolt
1-S323.....3/8-16 x 2" hex bolt
2-S666.....3/8 x 3/4" o.d. washer

25103-206-08 Pulley kit

1-6371A-08...crank pulley
3-S292.....3/8-24 x 1" shcs
1-2012A-08...water pump pulley
4-S550.....8mm x 1.25 x 20mm shcs
1-221A-08.....alternator fan
1-206A-08.....alternator pulley
1-S685.....11/16 lock washer

Power steering pulleys

1-623A-08.....keyway (kit 25103-08)
or
1-624A-08.....press fit (kit 25108-08)

shcs= socket head cap screw

For technical questions please call 888-729-9070



Step 1

Install four of (S338) 3/8-16 x 2 1/2" studs into the engine block water pump mounting holes. Now install water pump gaskets.

Step 2

Slide the water pump (1988 to 1995 reverse rotation long water pump) over the four studs. On the passenger side install two of (S777) 3/4" o.d. x 2.820" long stainless spacers. On the driver side install two (S775) 3/4" o.d. x 2.720" stainless spacers.

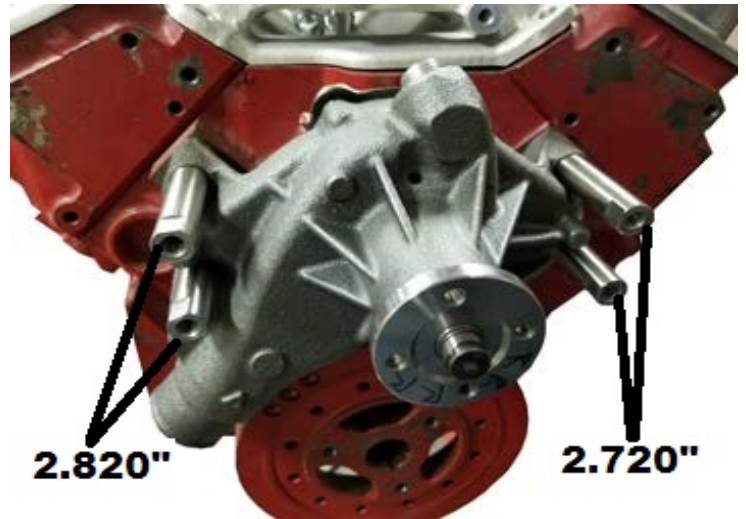

Step 3

Install (2012A-08) water pump pulley four (S550) M8-1.25 x 20mm shcs. Now install (6371A-08) crank pulley using three (S292) 3/8-24 x 1" shcs-.



Step 4

Install (25116A-08) alternator & a/c bracket with two (S248) 3/8-16 x 1" shcs. Leave slightly loose until alternator has been installed.

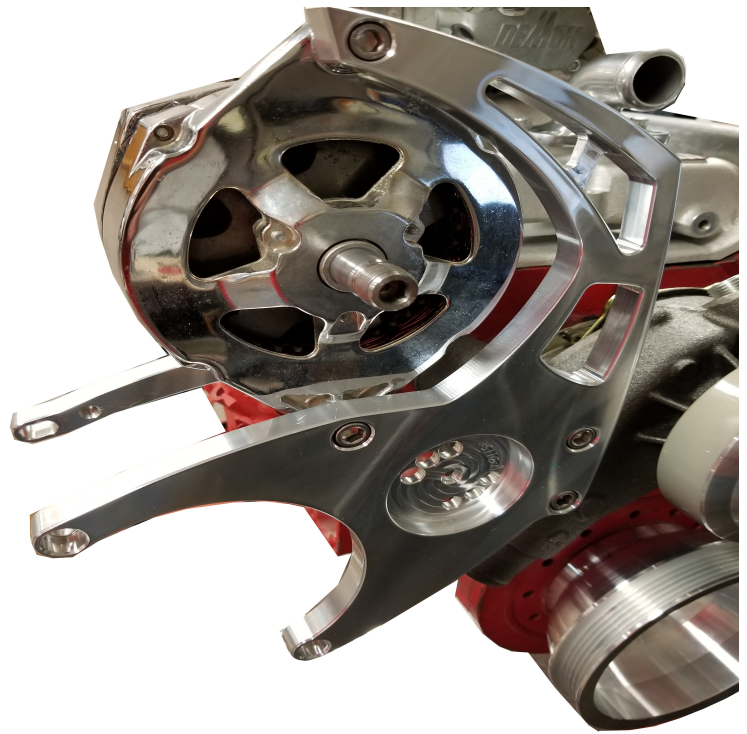
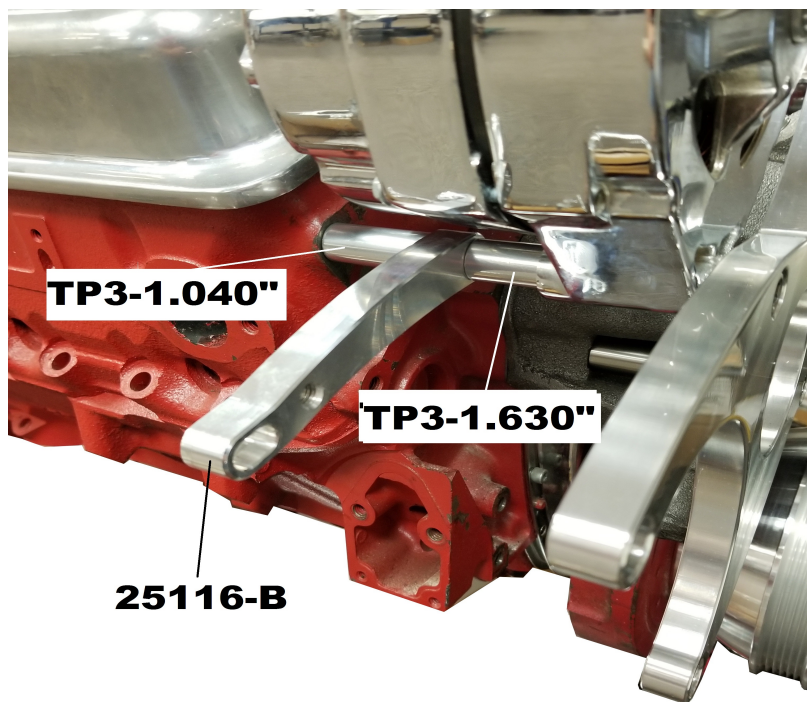

Step 5

Install GM 10si style alternator to the backside of (25116A-08) alternator & a/c bracket with a (S146) 5/16-18 x 1" shcs through the upper mounting hole. In the bottom mounting hole use a (S282) 3/8-16 x 6" shcs through the bracket and alternator ear and then a (TP3-1.630) tube spacer, (25116B-08) rear support bracket and (TP3-1.040) tube spacer threaded in to the cylinder head. Make sure slotted portion of rear bracket (25116B-08) is on the outside for a/c compressor to mount to as shown in photos above. Leave loose until compressor is fully installed.

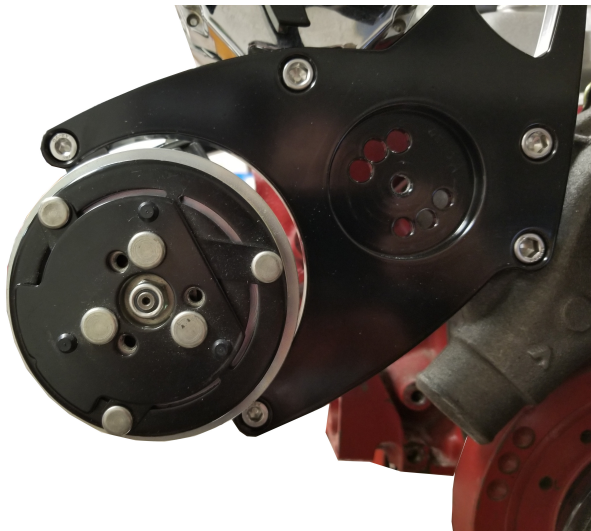

Step 6

Install Sanden 7176 a/c compressor to backside of (25116A-08) main bracket with two (S551) 8mm x 1.25 x 25mm shcs.

Step 7

Secure (25116B-08) rear support bracket to the rear compressor ear with a (S216) 5/16-18 x 2" hex bolt with two (S660) 5/16" washers and a (S616) 5/16-18 lock nut. Now tighten all of the alternator & a/c bracket bolts.

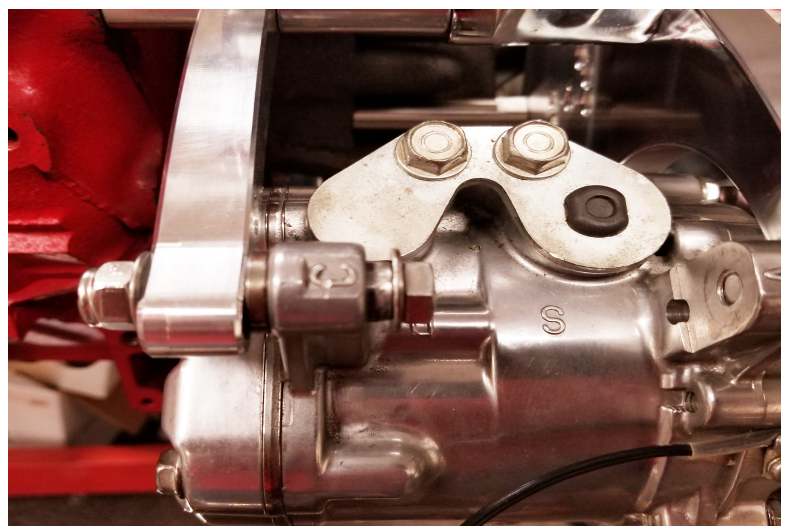

Step 8

Install (221A-08) alternator fan, (206A-08) alternator pulley and provided (S685) lock washer with alternator nut. Use impact to secure nut or torque to 90 lbs.



Step 9

If your power steering pump has a stud or bolt (as shown in photo) on backside of pump it will need to be removed. Now install (25114B-08) rear support bracket with a TP3-.700 spacer in between pump and bracket using a (S323) 3/8-16 x 2" hex bolt and a (S666) 3/8 x 3/4" washer. Leave slightly loose for now.

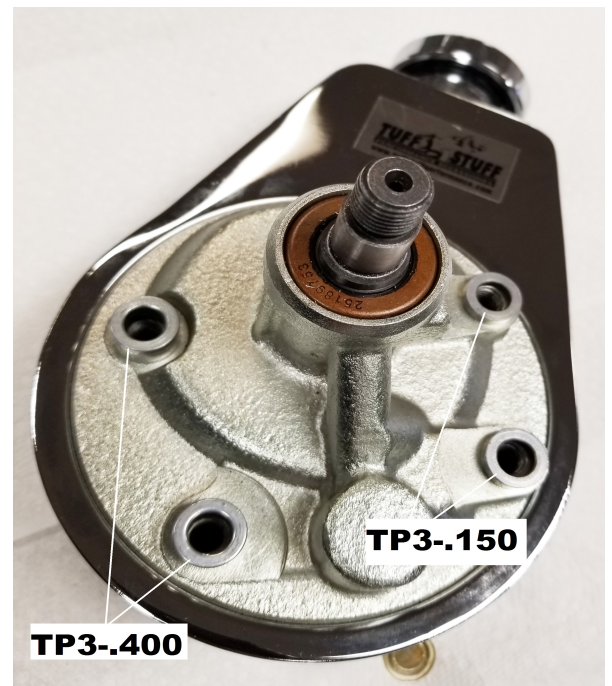

Step 10

On front of power steering pump add two (TP3-.150) spacers to the right two hole positions of power steering pump and two (TP3-.400) spacers to the left side mounting holes of the pump as shown.

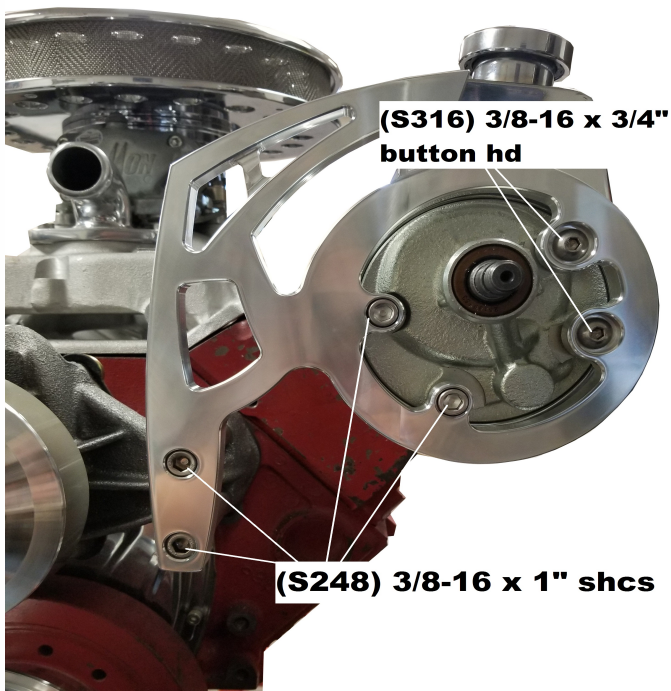

Step 8

Install (25114A-08) power steering main bracket to power steering pump with two (S248) 3/8-16 x 1" shcs and two TP3-.400 spacers as shown in step 7. On right side install two (S316) 3/8-16 x 3/4" button head bolts and two TP3-.150 spacers also as shown. Now install pump and bracket to (S775) stainless threaded spacers with two (S248) 3/8-16 x 1" shcs but leave loose as you will need movement to install rear support bracket.

Step 9

Install (25114B-08) to outer cylinder head bolt with a (S322) 3/8-16 x 1 1/2" hex bolt and a (S666) 3/8 x 3/4" washer. In between bracket and cylinder head use a (TP3-.300) spacer. Now tighten the front main power steering bracket bolts and then the two rear support bracket bolts. **Note: due to variations in cylinder heads it may be necessary to add shims to rear support bracket.**

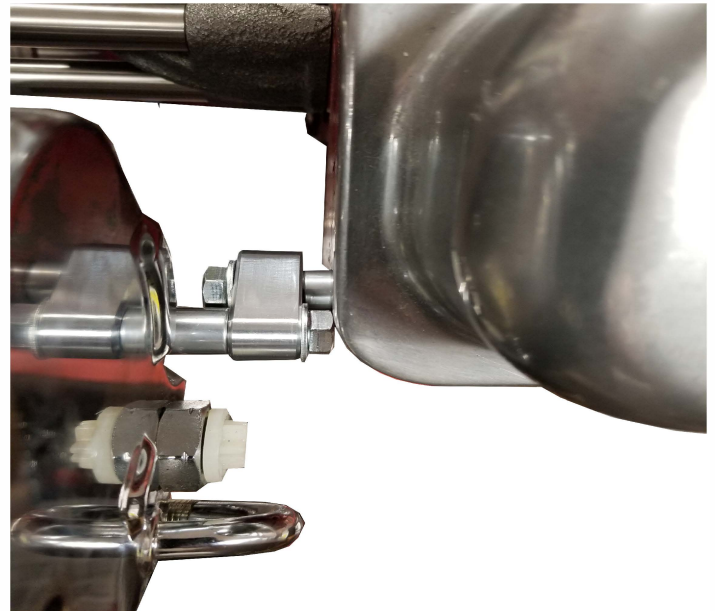

Step 10

To install power steering pulley. Kit 25103-08 includes (623A-08) keyway pulley which is installed by lining up pulley with key on shaft and then slide pulley on. Retain pulley with nut. **Note: Make sure key does not move in shaft when installing pulley as this may cause pulley failure.** Kit 25108-08 includes (624A-08) this pulley is installed with a power steering pulley install press tool. Press pulley on until correct alignment is achieved.

Step 12

Install (P758) spring tensioner to alternator bracket pocket. Use two (S660) 5/16 washers, (S160) 5/16-18 x 2 3/4" shcs and a (S616) 5/16 lock nut. One washer on the front of tensioner and one on the rear of bracket. There are 3 positions the tensioner can be installed in. This is to aid with variations in belt length and custom configurations. For the recommended belt, install the tensioner first in the middle position. Before tightening the bolt install belt over tensioner pulley as shown then tighten tensioner bolt.



Step 13

To install belt, use a 1/2" drive ratchet and rotate clockwise and install a 82.5" 6 rib belt and route belt as shown below. We recommend **Dayco part # 5060825**.

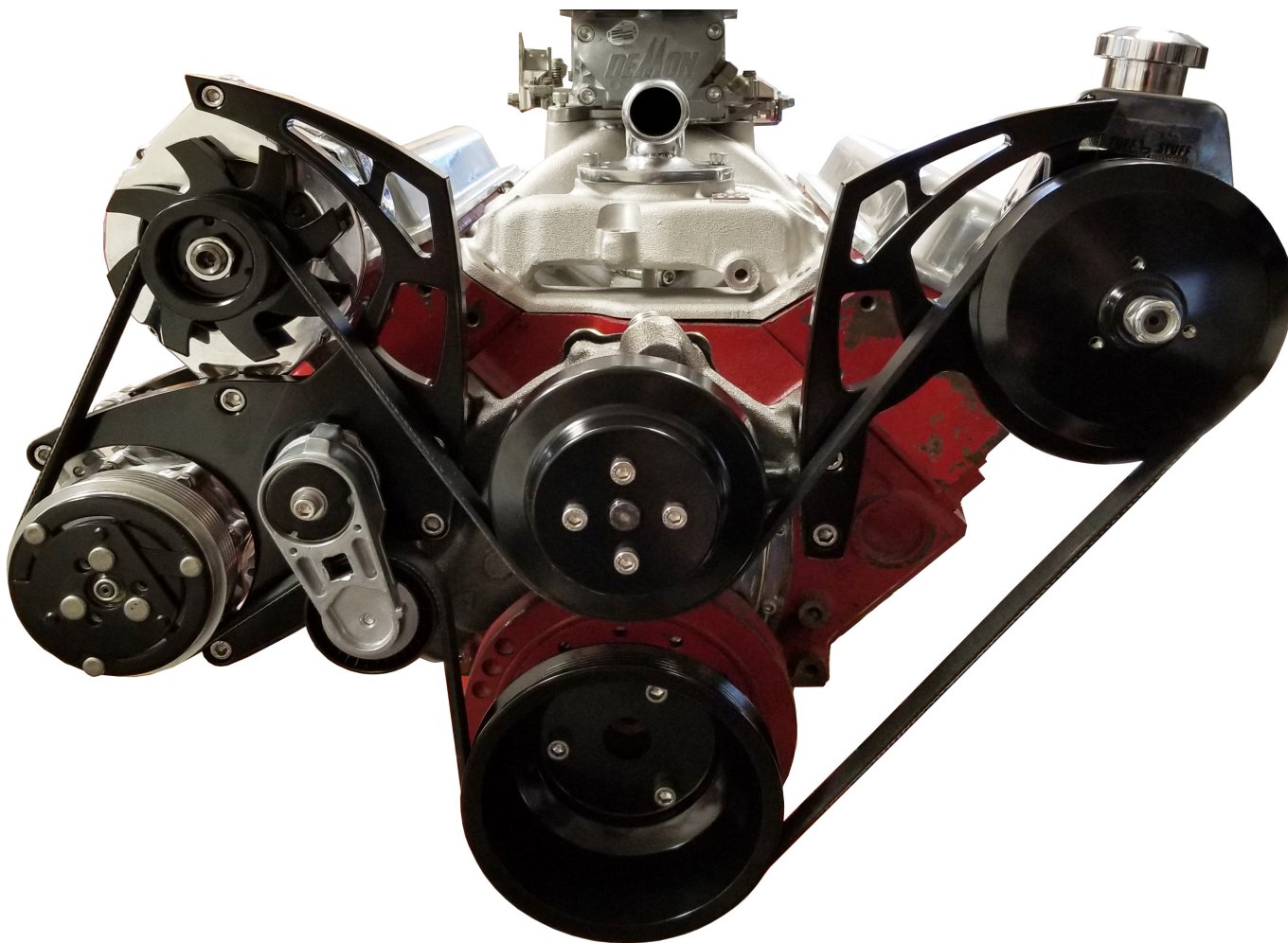

LIMITED WARRANTY

March Performance warrants to the original retail purchaser that for a period of ninety (90) days from the date of purchase, March Performance will repair or replace, at their option, any Product, which is found to be defective in material or workmanship.

Exclusions from Warranty Coverage

March Performance does not warrant any Product that is damaged from abuse, misuse or misapplication or not used for its intended purposes.

This Limited Warranty does not cover or apply to any damage or loss sustained to the engine or any other parts which may have been caused by the defective Product and does not cover or apply to any personal injury, labor charges or any other incidental costs for damages caused by the defective Product. THIS IS THE ONLY EXPRESS WARRANTY GIVEN WITH RESPECT TO YOUR PRODUCT. ALL OTHER EXPRESS WARRANTIES, GUARANTEES, OR STATEMENTS REGARDING THE PRODUCT, WHETHER WRITTEN OR VERBAL, ARE HEREBY DEEMED NULL AND VOID AND OF NO EFFECT.

Normal wear and tear and damage to the Product not caused by March Performance are also excluded from this Warranty.

DISCLAIMER OF OTHER WARRANTIES

EXCEPT TO THE EXTENT PROHIBITED BY APPLICABLE LAW, ANY IMPLIED WARRANTY WHETHER OF MERCHANTABILITY, FITNESS FOR A PARTICULAR PURPOSE, OR WARRANTY, SOME STATES DO NOT ALLOW LIMITATIONS ON HOW LONG AN IMPLIED WARRANTY WILL LAST SO THAT THE PRECEDING LIMITATION MAY NOT APPLY TO YOU.

Limitation on Remedies

REPAIR OR REPLACEMENT AS PROVIDED IN THIS WARRANTY IS YOUR EXCLUSIVE REMEDY. MARCH PERFORMANCE SHALL NOT BE LIABLE FOR ANY INCIDENTAL OR CONSEQUENTIAL DAMAGE FOR BREACH OF ANY EXPRESS OR IMPLIED WARRANTY ON THE PRODUCT. SOME STATES DO NOT ALLOW THE EXCLUSION OR LIMITATION OF INCIDENTAL OF CONSEQUENTIAL DAMAGES SO THE PROCEEDING LIMITATIO OR EXCLUSIONS MAY NOT APPLY TO YOU. YOU HAVE NO RECOURSE OR REMEDY FOR DAMAGE OR DEFECT CAUSED BY MISUSE, ABUSE OR NEGLIGENCE.

THIS WARRANTY GIVES YOU SPECIFIC RIGHTS AND YOU MAY ALSO HAVE OTHER RIGHTS, WHICH MAY VARY FROM STATE TO STATE.

Your Responsibilities:

- 1. Use and install the Product only for its intended purpose.
2. To avail yourself of this Limited Warranty, return the Product with a copy of the paid receipt, postage paid to: MARCH PERFORMANCE 16160 PERFORMANCE WAY NAPLES, FL 34110
3. When returning the Product, you must follow the directions set forth on the Warranty/Return Form on the reverse side of this Limited Warranty. If you no longer have the Warranty/Return Form, one may be obtained by contacting March Performance during normal business hours at: (888) 729-9070.
4. Shipping and/or transportation costs returning the Product to March Performance and any damage caused during shipping are your responsibility. March Performance will pay for shipping and/or transportation costs incurred in returning the Product to you.

LIMITED WARRANTY WARRANTY/RETURNS FORM

No product mounted is considered for credit unless it is a manufacturer defect.

All products returned for any reason must reference an authorization number (RGA). The RGA number is obtained by calling place of purchase during normal business hours. Any product returned without the RGA# written on the return package next to the return shipping label will be refused.

All returns must ship via UPS and be properly packaged in the original carton. Return freight charges are the responsibility of the customer unless the product was shipped in error.

March product returned after (1) year from date of purchase will not be accepted unless it is found to be a manufacturer defect. The customer must include a written statement describing the alleged product defect. The complete Limited Warranty is set forth on the reverse side.

- 100% credit issued on manufacturer defects
20% return fee on all reshelvable product
30% return fee on all repairable product

NO CREDIT WILL BE ISSUED ON RETURNED PRODUCT BEYOND REPAIR

March Performance thoroughly inspects all returns. It is the sole discretion of March Performance in determining the condition of all returned merchandise.

To receive replacements at no charge the original product must first be received and inspected by March Performance for determination. Immediate replacements may be purchased and later credited upon inspection determination.

Please Complete the Information below, detach and include with returned product.

Form fields for RGA#, CT#, Issued by, Date, Purchaser's Name, Phone, Address, Purchased Directly Through, Invoice#, Product ID, Invoice Date, Reason.

** MOUNTED PRODUCTS ARE NONREFUNDABLE **