

ULTRA DRIVE 2

Kit 25455

Optional parts for kits



Stainless braided hose packages for plumbing your power steering system



Part # P306 power steering psi regulator kit. Typically required for most rack & pinion systems



Part # P545 320amp alternator



We are specialists in matching aftermarket air conditioning systems such as Vintage Air, Old Air Products and Nostalic Air with our drive systems. Please contact us for help in selecting a matching kit for your application. 888-729-9070

Parts List

25401 alternator bracket

1-25401-A main alt bracket
1-25401-B rear alt support bracket
1-25404-B driver side wing support bracket
2-S248 3/8-16 x 1" shcs
1-S277 3/8-16 x 4.75" shcs
1-S339 3/8-16 x 3" stud
1-S343 3/8-16 x 3.5" stud
1-S551 M8 - 1.25 x 25mm shcs
2-S675 water pump gaskets
1-S777 2.820" threaded spacer
1-S793 2.320" threaded spacer
1-AC3-1.880.. 1.880" alum. spacer

25402 air conditioning bracket

1-25402-A a/c main bracket
1-25402-B a/c rear support bracket
1-25402-C a/c outer rear support bracket
1-25404-A pass side wing support bracket
1-P758-A tensioner
1-759-A tensioner cover
2-S022 8-32 x .375" shcs
1-S160 5/16-18 x 2.75" shcs
1-S162 5/16-18 x 3" shcs
1-S213 5/16-18 x 1.5" hex head
2-S248 3/8-16 x 1" shcs
1-S312 3/8-16 x 1" hex head
1-S340 3/8-16 x 4" stud
1-S343 3/8-16 x 3.5" stud
2-S551 M8-1.25 x 25mm shcs
1-S616 5/16-18 lock nut
4-S660 5/16 washer
1-S666 3/8 washer
2-S675 water pump gaskets
1-S770 1.900" threaded spacer
1-S793 2.320" threaded spacer
1-TP3-.150150" spacer
1-TP5-1.170 .. 1.170" spacer

20255 wing bracket

1-20255-A wing bracket
2-S120 1/4-20 x .75 flat head

6300-206 pulley kit

1-6301-A crank pulley
3-S292 3/8-24 x 1" shcs
1-6302 water pump pulley
4-S183 5/16-24 x .625 shcs
1-221-A alternator fan
1-206-A alternator pulley
1-S685 11/16 lock washer
1-306-A alternator pulley cover
3-S028 8-32 x 1" shcs
1-394-A a/c clutch cover
3-S124 1/4-20 x .75 button head
3-S520 M6-1.0 x 20mm button head

535 p/s pulley

1-535-A p/s pulley
1-302-A pulley cover
3-S022 8-32 x .375" shcs

21109-09 power steering bracket

1-21109A-09 .. front p/s bracket
1-21109B-09 ... rear p/s bracket
1-20114C-09 ... spacer block
2-S270 3/8-16 x 3.5" shcs
2-S311 3/8-16 x .75" hex head
1-S312 3/8-16 x 1" hex head
1-TP3-.150150" spacer

accessories

1-P112 aluminum water pump
1-P412 chrome a/c compressor
1-P572 chrome 140amp alternator
1-417-A a/c manifold
 2-S550 M8-1.25 x 20mm shcs
1-P304 chrome Saginaw keyed p/s pump

shcs = socket head cap screw

**For technical assistance please
call 1-888-729-9070**

Step 1

Insert the four 3/8-16 studs into the block as shown in photo threading them 1/2 inch into the block. In the upper passenger and driver side install (S343) 3/8-16 x 3.5" studs. In lower passenger side use a (S340) 3/8-16 x 4" stud and in the lower driver side use (S339) 3/8-16 x 3" stud. Place 2 (S675) water pump gaskets over studs and then slide on (25401-B) alt rear support bracket on driver side and then (25402-B) a/c rear support on passenger side. Now add 2 more (S675) gaskets.

25402-B a/c rear
support bracket

25403-B Alternator
Rear support
bracket

PHOTO-1

3/8-16 x 3-1/2" Stud
(S343)

3/8-16 x 4" Stud
(S340)



3/8-16 x 3-1/2" Stud
(S343)

3/8-16 x 3" Stud
(S339)

Step 2

Install (P112) water pump over studs. On upper passenger stud install (25404-A) a/c wing support bracket and secure with a (S793) 2.320" long threaded spacer. On upper driver side install (25404-B) alternator wing support bracket and secure with a (S793) 2.320" long threaded spacer. Finger tight both spacers. On lower passenger side stud use a (S770) 1.900" long threaded spacer and the lower driver side stud use a (S777) 2.820" long spacer.

25404-A wing support
2.320 threaded spacer
(S793)

(S770) 1.900 Spacer

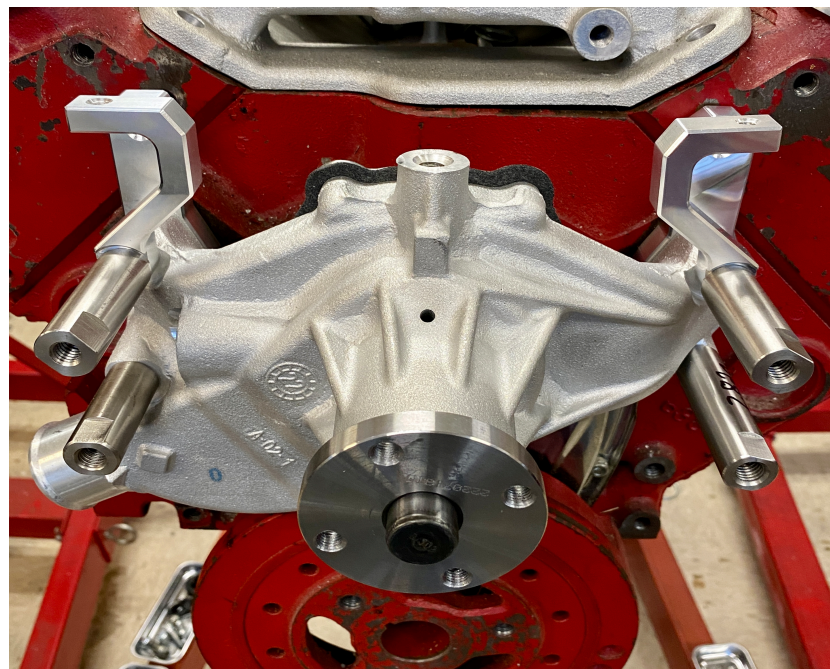

25404-B wing support
2.320 spacer
(S793)

(S777) 2.820 spacer

Step 3

Install (20255-) wing support bracket to the two wing supports using two (S120) 1/4-20 x .75" flat head screws. After installing the wing bracket tighten the four threaded spacers .

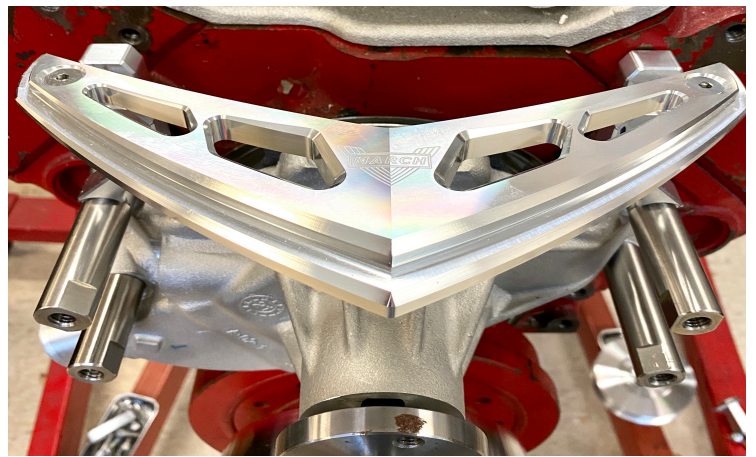
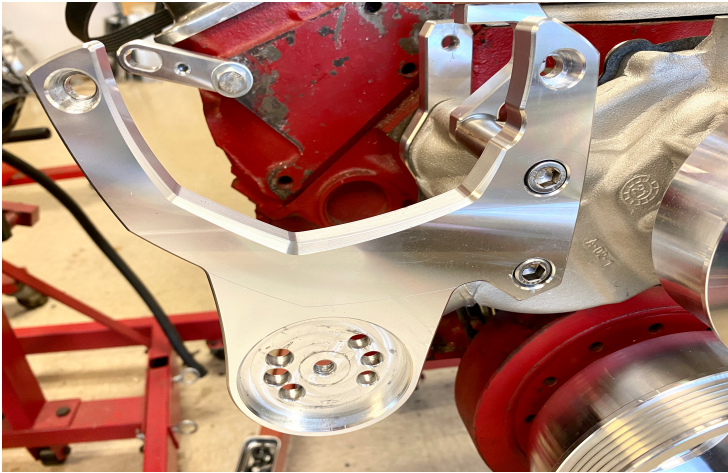

Step 4

Install (25402-A) to the two threaded spacers on the passenger side with two (S248) 3/8-16 x 1" shcs as shown. Now install (25402-C) rear outer a/c ear support bracket to the outer cylinder head bolt hole with a (S312) 3/8-16 x 1" hex head bolt and a (S666) 3/8 washer. Leave finger tight at this time.

Step 5

Install (P412) a/c compressor to the a/c bracket with two (S551) M8-1.25 x 25mm shcs **NOTE: the compressor mounts to the rear side of the a/c bracket as shown.**

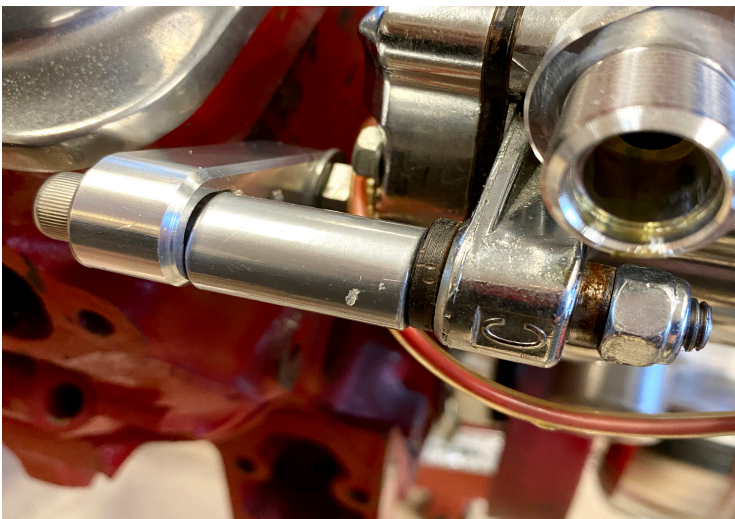

Step 6

Attach the rear a/c outer support bracket to the outer compressor ear with a (S160) 5/16-18 x 2-3/4" shcs installing it from the back of the bracket through a (TP5-1.170) spacer, then through the ear of the compressor . Use a (S660) 5/16 washer and retain with a (S616) 5/16 lock nut.

Step 7

Attach the rear inner a/c ear to the a/c rear support bracket with a (S213) 5/16-18 x 1.25" hex head bolt and a (S660) washer thru the rear a/c ear with a (TP3-.150") spacer between the rear bracket and the a/c ear as shown.

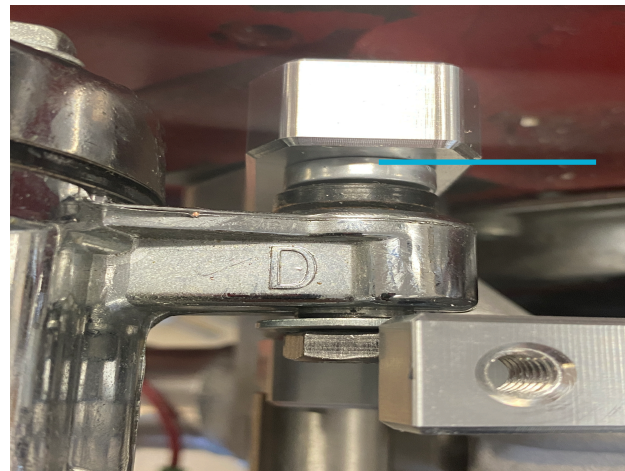

TP3-.150
Spacer



Step 8

Install (25401-A) alternator bracket to the two threaded spacers on the drivers side using two (S248) 3/8-16 x 1" shcs.

AC3-1.880
Spacer

Step 9

Install the (P572) alternator to the alternator bracket using a (S551) M8-1.25 x 25mm shcs at the outer mounting hole. At the inner mounting hole use a (S277) 3/8-16 x 4.75" shcs and place a (AC3-1.880") 1.880" long aluminum spacer between the rear alternator ear and the rear alternator support bracket.





Step 10

Install (221-A) alternator fan with (206-A) alternator pulley and secure with the (S685) 11/16" lock washer and alternator nut. Torque to 70ft lbs. Now install the (306-A) alternator nose cover with three (S028) 8/32 x 1" shcs.

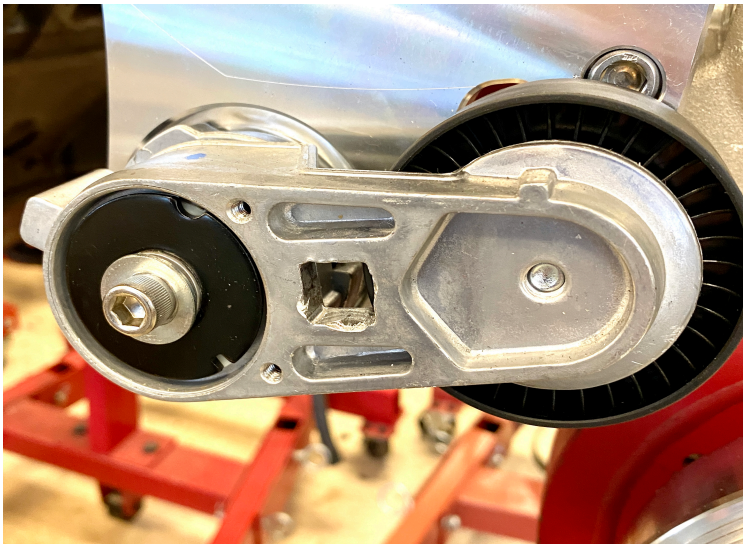

EFW##

;` eS^/B) ' *fiTW fWeja` Wifa fZWbaU W]` fZW
 S!UTdSU VZGeVS/E#(\$fi' !#(Z#* j %šezUei [fZ
 fi a/E("fi' !#(i SeZWe/E("fia` WZWZW
 Xa` fS` Va` Wa fZWASZA` fZVISUj eVW
 eWgdW [fZS' !#('aU `gf/E(#fiZGeWZW
 UWfWefaxZa`W]` fZW/c bdsU Wfa 'aLSfW
 fZWWeja` Wfi

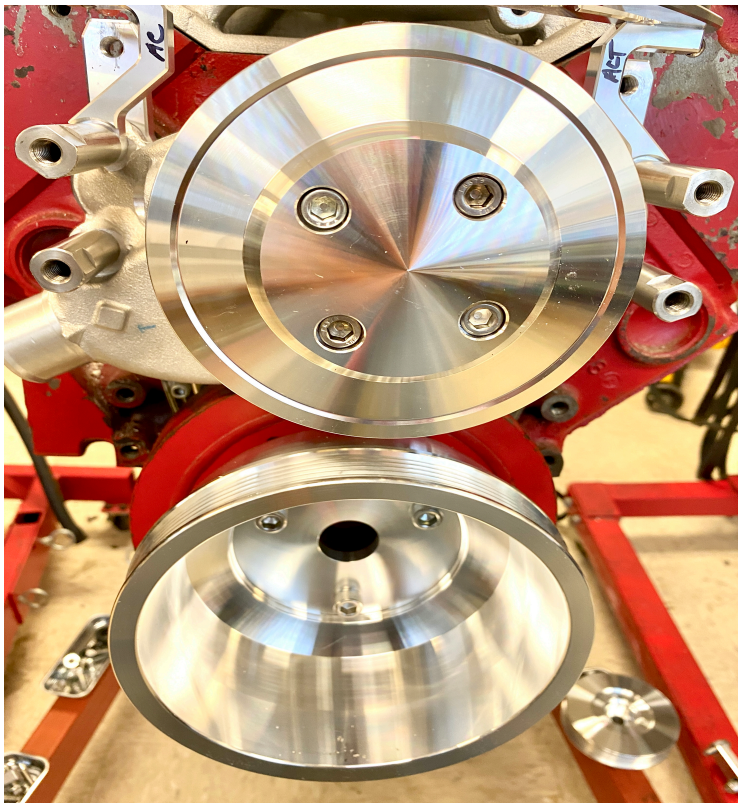

Step 12

Mount the (6301-A) crank pulley with three (S292) 3/8-24 x 1" shcs. Mount (6302-A) water pump pulley with four (S183) 5/8-24 x .625" shcs.

Step-13

To install (P304-A) power steering pump and (21109-09) power steering bracket start by first **removing the stud** from back of (P304) power steering pump.

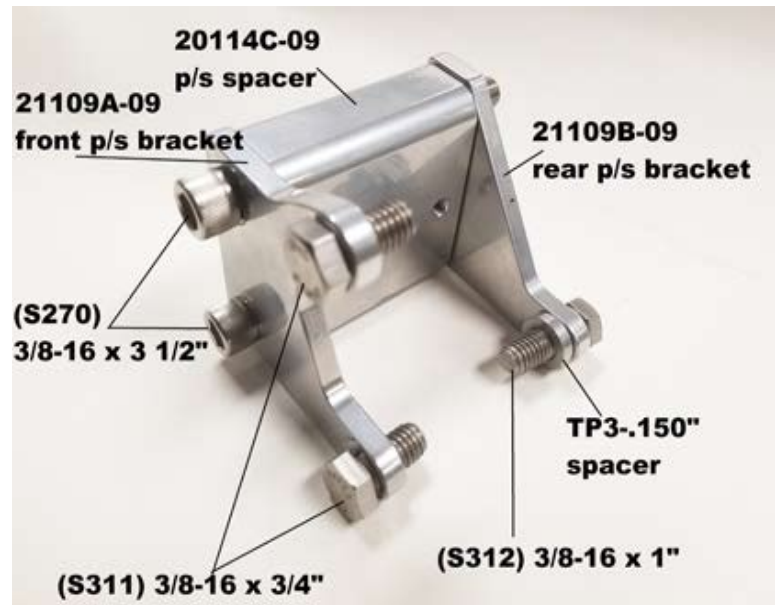

Step-14

Install (21109A-09) to front of pump as shown with two (S311) 3/8-16 x 3/4" hex heads.

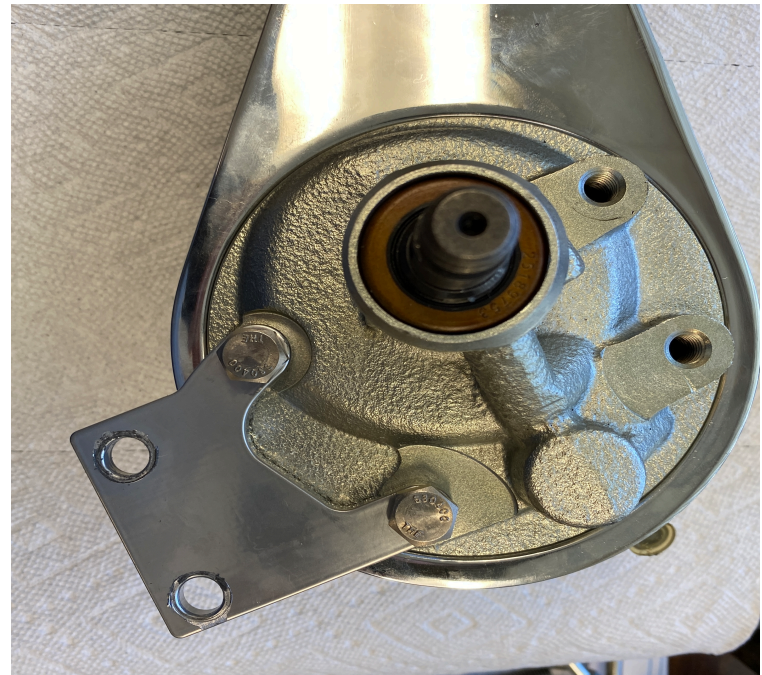

Step-15

Install (21109B-09) rear support bracket to backside of pump where stud was with a (S312) 3/8-16 x 1" hex head. Use (TP3-.150") spacer in between pump and bracket.

Step-16

Install pump and bracket assembly to the lower driver side of the engine block with two (S270) 3/8-16 x 3 1/2" SHCS and (20114C-09) in between the front and rear brackets as shown in photo.

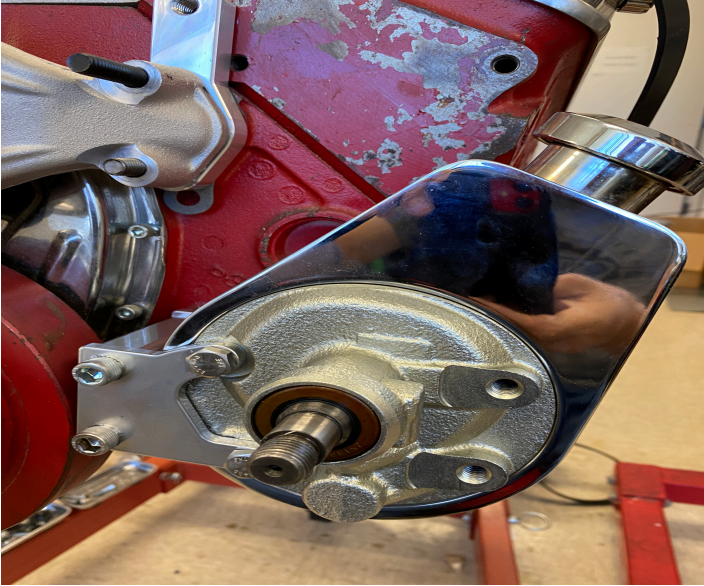

Step-17

Install (535-A) power steering pulley to power steering pump and retain with lock nut. **Make sure woodruff key is straight on shaft of pump and does not slide up in rear upon install.** Now install pulley nose cover (302-A) with three (S022) 8-32 x 3/8" SHCS.

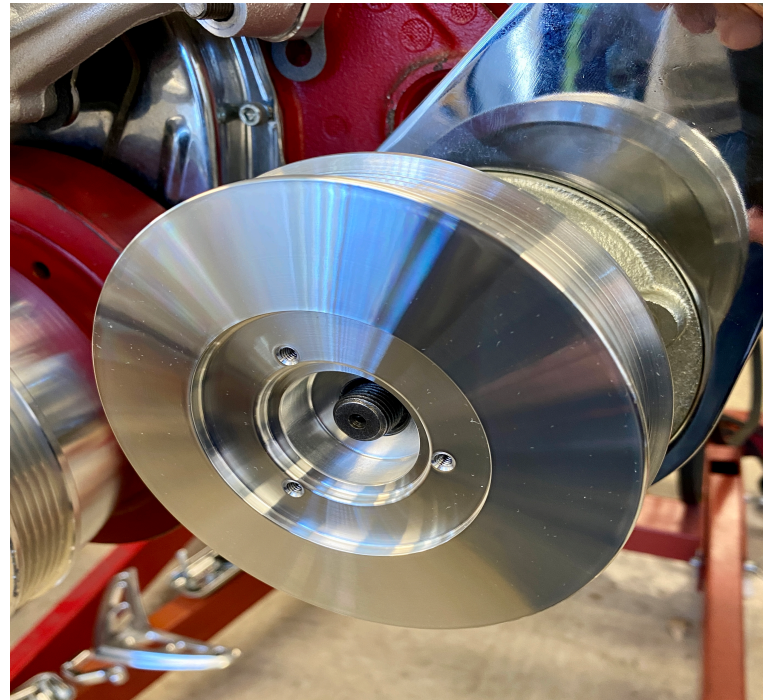

Step 18

Install the (394-A) a/c cover to front of clutch assembly using three (S520) M6-1.0 x 20mm button heads or three (S124) 1/4-20 x .75" button heads (S124). Both sets are provided due to variations in threads on compressors.

Step 19

Install belt. Use a 64.3" 6 rib belt or Dayco part number **5060643**. Use a 1/2 Ratchet and rotate the belt tensioner clockwise while installing the belt.

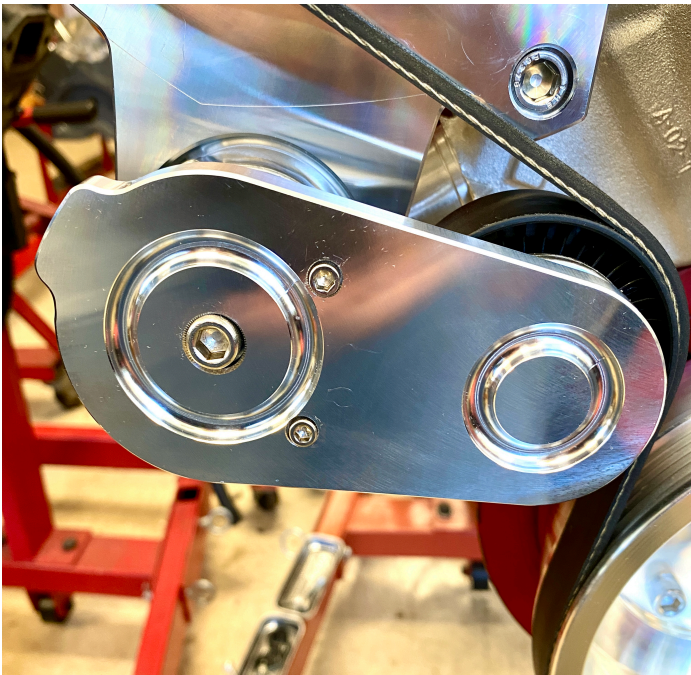
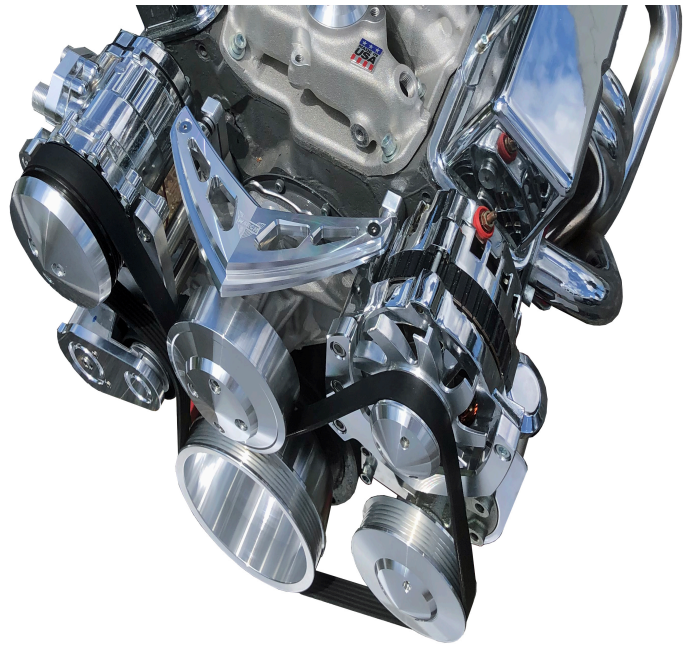

Step 20

Install (759-A) belt tensioner cover to tensioner with two (S022) 8-32 x .375" shcs.

Step 21

To install a/c lines first remove the a/c block off plate. Now install (417-A) a/c manifold using two (S550) M8-1.25 x 20mm shcs. Note the compressor comes with correct amount of oil inside it.

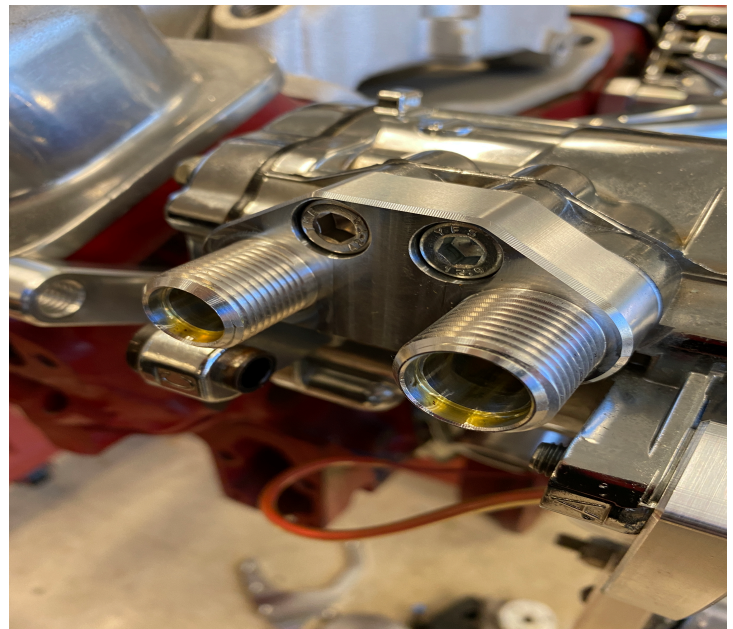

LIMITED WARRANTY

March Performance warrants to the original retail purchaser that for a period of ninety (90) days from the date of purchase, March Performance will repair or replace, at their option, any Product, which is found to be defective in material or workmanship.

Exclusions from Warranty Coverage

March Performance does not warrant any Product that is damaged from abuse, misuse or misapplication or not used for its intended purposes.

This Limited Warranty does not cover or apply to any damage or loss sustained to the engine or any other parts which may have been caused by the defective Product and does not cover or apply to any personal injury, labor charges or any other incidental costs for damages caused by the defective Product. THIS IS THE ONLY EXPRESS WARRANTY GIVEN WITH RESPECT TO YOUR PRODUCT. ALL OTHER EXPRESS WARRANTIES, GUARANTEES, OR STATEMENTS REGARDING THE PRODUCT, WHETHER WRITTEN OR VERBAL, ARE HEREBY DEEMED NULL AND VOID AND OF NO EFFECT.

Normal wear and tear and damage to the Product not caused by March Performance are also excluded from this Warranty.

DISCLAIMER OF OTHER WARRANTIES

EXCEPT TO THE EXTENT PROHIBITED BY APPLICABLE LAW, ANY IMPLIED WARRANTY WHETHER OF MERCHANTABILITY, FITNESS FOR A PARTICULAR PURPOSE, OR WARRANTY, SOME STATES DO NOT ALLOW LIMITATIONS ON HOW LONG AN IMPLIED WARRANTY WILL LAST SO THAT THE PRECEDING LIMITATION MAY NOT APPLY TO YOU.

Limitation on Remedies

REPAIR OR REPLACEMENT AS PROVIDED IN THIS WARRANTY IS YOUR EXCLUSIVE REMEDY. MARCH PERFORMANCE SHALL NOT BE LIABLE FOR ANY INCIDENTAL OR CONSEQUENTIAL DAMAGE FOR BREACH OF ANY EXPRESS OR IMPLIED WARRANTY ON THE PRODUCT. SOME STATES DO NOT ALLOW THE EXCLUSION OR LIMITATION OF INCIDENTAL OF CONSEQUENTIAL DAMAGES SO THE PROCEEDING LIMITATIO OR EXCLUSIONS MAY NOT APPLY TO YOU. YOU HAVE NO RECOURSE OR REMEDY FOR DAMAGE OR DEFECT CAUSED BY MISUSE, ABUSE OR NEGLIGENCE.

THIS WARRANTY GIVES YOU SPECIFIC RIGHTS AND YOU MAY ALSO HAVE OTHER RIGHTS, WHICH MAY VARY FROM STATE TO STATE.

Your Responsibilities:

1. Use and install the Product only for its intended purpose.
2. To avail yourself of this Limited Warranty, return the Product with a copy of the paid receipt, postage paid to:
MARCH PERFORMANCE
16160 PERFORMANCE WAY
NAPLES, FL 34110
3. When returning the Product, you must follow the directions set forth on the Warranty/Return Form on the reverse side of this Limited Warranty. If you no longer have the Warranty/Return Form, one may be obtained by contacting March Performance during normal business hours at: (888) 729-9070.
4. Shipping and/or transportation costs returning the Product to March Performance and any damage caused during shipping are your responsibility. March Performance will pay for shipping and/or transportation costs incurred in returning the Product to you.

LIMITED WARRANTY WARRANTY/RETURNS FORM

No product mounted is considered for credit unless it is a manufacturer defect.

All products returned for any reason must reference an authorization number (RGA). The RGA number is obtained by calling place of purchase during normal business hours. **Any product returned without the RGA# written on the return package next to the return shipping label will be refused.**

All returns must ship via UPS and be properly packaged in the original carton. Return freight charges are the responsibility of the customer unless the product was shipped in error.

March product returned after (1) year from date of purchase will not be accepted unless it is found to be a manufacturer defect. **The customer must include a written statement describing the alleged product defect.** The complete Limited Warranty is set forth on the reverse side.

- 100% credit issued on manufacturer defects
- 20% return fee on all reshelvable product
- 30% return fee on all repairable product

NO CREDIT WILL BE ISSUED ON RETURNED PRODUCT BEYOND REPAIR

March Performance thoroughly inspects all returns. It is the sole discretion of March Performance in determining the condition of all returned merchandise.

To receive replacements at no charge the original product must first be received and inspected by March Performance for determination. Immediate replacements may be purchased and later credited upon inspection determination.

Please Complete the Information below, detach and include with returned product.

RGA# _____ CT# _____ Issued by: _____ Date _____

Purchaser's Name _____ Phone _____

Address _____

Purchased Directly Through _____ Invoice# _____

Product ID _____ Invoice Date _____

Reason _____

**** MOUNTED PRODUCTS ARE NONREFUNDABLE ****